



CK 2000 Series

K Frame



Continental Pump Company

29425 State Hwy B | Warrenton, Missouri 63383 | Tel: 636-456-6006 | Fax: 636-456-4337 | Email: sales@con-pump.com

www.continentalultrapumps.com

- ① Radial Grease Seal
- ② Bearing Cover Plate
- ③ O-Ring for Bearing Cover Plate
- ④ Drive Shaft Head
- ⑤ O-Ring for Shaft Head
- ⑥ Primary Thrust Plate
- ⑦ Rotor Key
- ⑧ Ring Gear
- ⑨ Lock Nut
- ⑩ Gear Ball
- ⑪ Secondary Thrust Plate
- ⑫ Seal Support
- ⑬ Gear Joint Seal
- ⑭ Drive Shaft
- ⑮ Tapered Roller Bearing
- ⑯ Bearing Spacer
- ⑰ Bearing Lock Plug
- ⑱ Bearing Lock Nut
- ⑲ Thrust Grease Seal
- ⑳ Slinger Ring
- ㉑ Packing Gland Set
- ㉒ Packing
- ㉓ Lantern Ring Set
- ㉔ Bearing Housing
- ㉕ Suction Housing Retaining Ring
- ㉖ Clamp Ring
- ㉗ Suction Housing
- ㉘ Stator
- ㉙ Stator Support
- ㉚ Inspection Plate
- ㉛ Inspection Plate Gasket
- ㉜ Stator Gasket
- ㉝ Stator Retaining Ring
- ㉞ A Stator Ring Clip
B Stator Clamp Ring
- ㉟ Discharge Flange
- ㊱ Connecting Rod
- ㊲ Gear Joint Shell
- ㊳ Rotor
- ㊴ O-Ring for Rotor Head
- ㊵ Head Ring

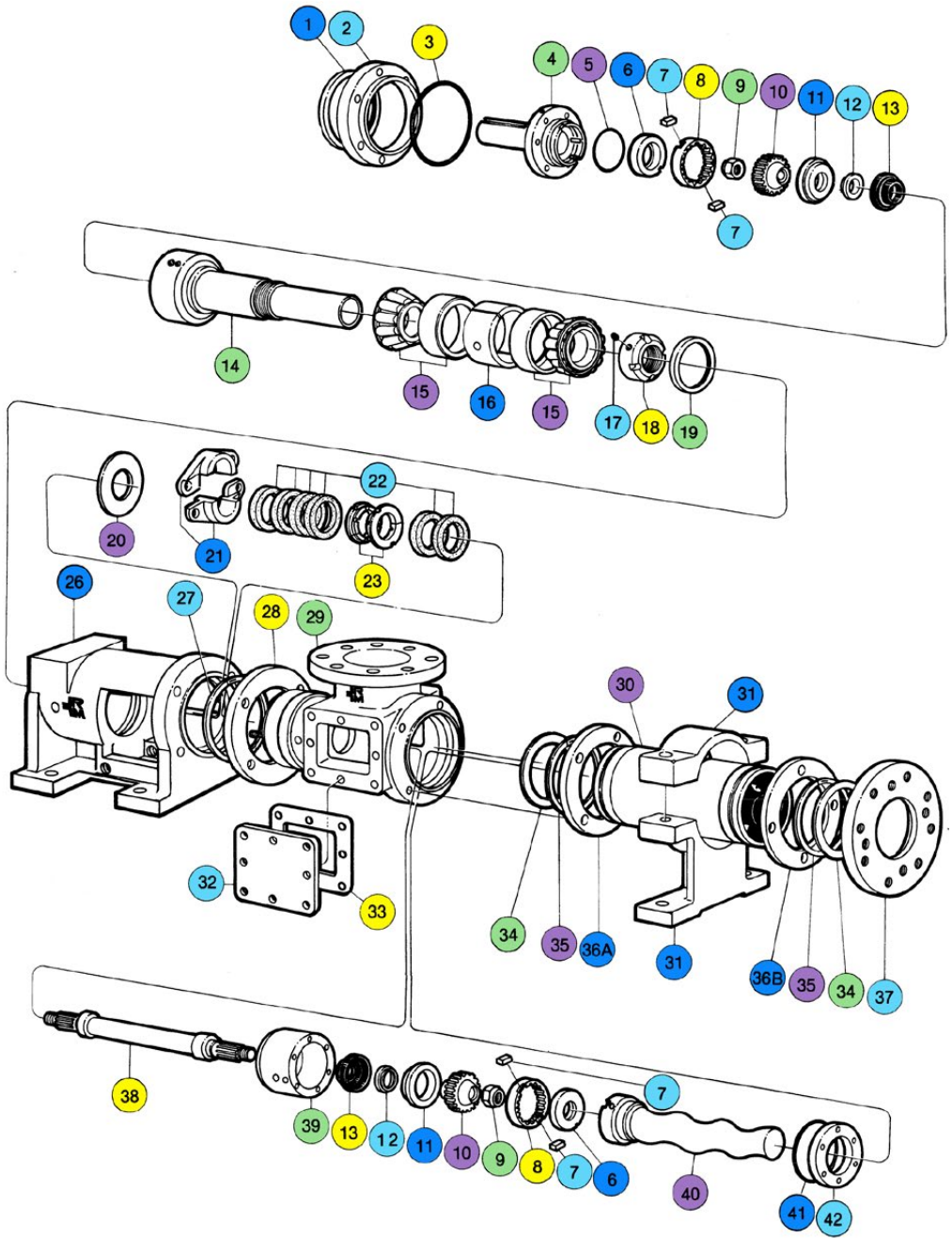

Gear Joint Kit (Includes quantity 1 each of part ⑥, ⑧, ⑩, ⑪, ⑫ and quantity of 2 of part ⑦.)

Bearing Kit (Includes quantity 1 each of part ①, ⑲ and quantity of 2 of part ⑮.)

Seal Kit 87 (Includes quantity 1 each of part ⑤, ⑴ and quantity of 2 of part ⑬.)

Seal Kit 88 (Includes quantity 1 each of part ⑤, ⑴ and quantity of 2 each of part ⑫, ⑬.)

Part	Part Name	Continental Pump Part Number	Materials
	Radial Grease Seal	PK0611CK	Steel
	Bearing Cover Plate	PK0341CK	Cast Iron
	O-Ring for Bearing Cover Plate	PK110QCK	Buna
	Drive Shaft Head	PK0971CK	Carbon Steel
	O-Ring for Shaft Head	BK114QCK	Buna
	Primary Thrust Plate	PK0981CK	Brass
	Rotor Keys (Set of 2)	RK0761CK	Carbon Steel
	Ring Gear	AK0952CK Not Sold Individually See P/N: KPK951CK	Carbon Steel

Continental Pump Company

Please Contact Us for Pricing.

Part	Part Name	Continental Pump Part Number	Materials
	Lock Nut	RK0581CK	Carbon Steel
	Gear Ball	AK0951CK Not Sold Individually See P/N: KPK951CK	Carbon Steel
	Secondary Thrust Plate	PK0982CK	Brass
	Seal Support	PK0891CK	Carbon Steel
	Gear Joint Seal	PK087QCK PK087BCK PK087FCK	Buna EPDM Viton
	Drive Shaft with Bearing Lock Nut (PK0581CK)	PK0261CK PK0266CK	Carbon Steel Stainless Steel
	Tapered Roller Bearing (Cone and Cup)	PK0311CK	Carbon Steel
	Bearing Spacer	PK0331CK	Carbon Steel

Continental Pump Company







29425 State Hwy B | Warrenton, Missouri 63383 | Tel: 636-456-6006 | Fax: 636-456-4337 | Email: sales@con-pump.com

www.continentalultrapumps.com

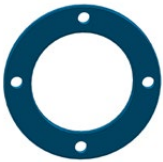
Part	Part Name	Continental Pump Part Number	Materials
	Bearing Lock Plug	P10762CK	Steel
	Bearing Lock Nut	PK0581CK	Carbon Steel
	Thrust Grease Seal	PK0621CK	Steel
	Slinger Ring	PK0771CK	Buna
	Packing Gland Set	PK041DCK PK041SCK	Carbon Steel Stainless Steel
	Packing (Braided)	PK0423CK PK0427CK	Graphite PTFE Teflon PTFE
	Lantern Ring Set	PK0571CK	Plastic Teflon
	Bearing Housing	PK0051CK	Cast Iron

Continental Pump Company

Please Contact Us for Pricing.

Part	Part Name	Continental Pump Part Number	Materials
	Suction Housing Retaining Ring	PK0085CK	Steel
	Clamp Ring	PK0932CK	Cast Iron
	Suction Housing K115, K175, K345 and K620	PK0021CK PK0026CK	Cast Iron Stainless Steel
	Suction Housing K800	PK0022CK PK0027CK	Cast Iron Stainless Steel
	Stator 6K115 Carbon Steel	C360JQCK C360JBCK C360JRCK	Buna EPDM Natural Rubber
	Stator 1K175 Carbon Steel	C310KQCK C310KBCK C310KRCK C310KFCK	Buna EPDM Natural Rubber Viton
	Stator 2K175 Carbon Steel	C320KQCK C320KBCK C320KRCK C320KFCK	Buna EPDM Natural Rubber Viton
	Stator 4K175 Carbon Steel	C340KQCK C340KBCK C340KRCK	Buna EPDM Natural Rubber

Continental Pump Company

29425 State Hwy B | Warrenton, Missouri 63383 | Tel: 636-456-6006 | Fax: 636-456-4337 | Email: sales@con-pump.com

www.continentalultrapumps.com

Please Contact Us for Pricing.







Part	Part Name	Continental Pump Part Number	Materials
	Stator 6K175 Carbon Steel	C360KQCK C360KBCK C360KRCK	Buna EPDM Natural Rubber
	Stator 1K345 Carbon Steel	C3145QCK C3145BCK C3145RCK	Buna EPDM Natural Rubber
	Stator 2K345 Carbon Steel	C3245QCK C3245BCK C3245RCK	Buna EPDM Natural Rubber
	Stator 3K345 Carbon Steel	C3345QCK C3345BCK C3345RCK	Buna EPDM Natural Rubber
	Stator 1K620 Carbon Steel	C3162QCK C3162BCK C3162RCK	Buna EPDM Natural Rubber
	Stator 2K620 Carbon Steel	C3262QCK C3262BCK C3262RCK C3262FCK	Buna EPDM Natural Rubber Viton
	Stator 1K800 Carbon Steel	C3180QCK C3180BCK C3180RCK	Buna EPDM Natural Rubber
	Stator 2K800 Carbon Steel	C3280QCK C3280BCK C3280RCK	Buna EPDM Natural Rubber

Continental Pump Company

29425 State Hwy B | Warrenton, Missouri 63383 | Tel: 636-456-6006 | Fax: 636-456-4337 | Email: sales@con-pump.com

www.continentalultrapumps.com

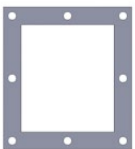
Please Contact Us for Pricing.









Part	Part Name	Continental Pump Part Number	Materials
	Stator Support K115	BK0382CK	Cast Iron
	Stator Support K175, K345 and K620	Bk0381CK	Cast Iron
	Stator Support K800	BK0383CK	Cast Iron
	Inspection Plate K115, K175, K345 and K620	BJ0171CK BJ0176CK	Cast Iron Stainless Steel
	Inspection Plate K880	BJ0172CK BJ0177CK	Cast Iron Stainless Steel
	Inspection Plate Gasket	BJ079QCK BJ079BCK BJ079FCK	Buna EPDM Viton
	Stator Gasket K115	BH085QCK BH085BCK BH085FCK	Buna EPDM Viton
	Stator Gasket K175, K345, K620 and K800	BK085QCK BK085BCK BK085FCK	Buna EPDM Viton

Continental Pump Company

29425 State Hwy B | Warrenton, Missouri 63383 | Tel: 636-456-6006 | Fax: 636-456-4337 | Email: sales@con-pump.com

www.continentalultrapumps.com

Please Contact Us for Pricing.

Part	Part Name	Continental Pump Part Number	Materials
	Stator Retaining Ring K115	AH0084CK	Steel
	Stator Retaining Ring K175, K345 and K620	AK0084CK	Steel
	Stator Retaining Ring K800	AK0085CK	Steel
	Stator Ring Clip K115 (6 Stage)	AK0933CK	Cast Iron
	Stator Clamp Ring K115 (6 Stage)	AJ0992CK	Cast Iron
	Stator Ring Clip K175 (1, 2, 3, 4, and 6 Stage)	AK0932CK	Cast Iron
	Stator Clamp Ring K175 (4 and 6 Stage)	WK0932CK	Cast Iron
	Stator Ring Clip K345 and K620 (1 Stage)	AK0932CK	Cast Iron

Continental Pump Company

29425 State Hwy B | Warrenton, Missouri 63383 | Tel: 636-456-6006 | Fax: 636-456-4337 | Email: sales@con-pump.com

www.continentalultrapumps.com

Please Contact Us for Pricing.

Part	Part Name	Continental Pump Part Number	Materials
	Stator Clamp Ring K345 and K620 (1 Stage)	AK0932CK	Cast Iron
	Stator Ring Clip K345 (2 and 3 Stage)	AK0932CK	Cast Iron
	Stator Clamp Ring K345 (2 and 3 Stage)	WK0932CK	Cast Iron
	Stator Ring Clip K620 (1 and 2 Stage)	AK0932CK	Cast Iron
	Stator Clamp Ring K620 (1 and 2 Stage)	AK0932CK	Cast Iron
	Stator Ring Clip K800 (1 and 2 Stage)	AK0934CK	Cast Iron
	Stator Clamp Ring K800 (1 and 2 Stage)	AK0934CK	Cast Iron
	Discharge Flange K115 (6 Stage)	BJ0120CK BJ0125CK	Cast Iron Stainless Steel

Continental Pump Company

29425 State Hwy B | Warrenton, Missouri 63383 | Tel: 636-456-6006 | Fax: 636-456-4337 | Email: sales@con-pump.com

www.continentalultrapumps.com

Please Contact Us for Pricing.







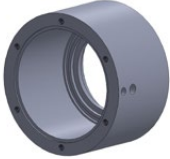

Part	Part Name	Continental Pump Part Number	Materials
	Discharge Flange K175 (1, 2, and 3 Stage)	BK0121CK BK0126CK	Cast Iron Stainless Steel
	Discharge Flange K175 (4 and 6 Stage)	WK0121CK WK0126CK	Cast Iron Stainless Steel
	Discharge Flange K345 (1 Stage)	BK0121CK BK0126CK	Cast Iron Stainless Steel
	Discharge Flange K345 (2 and 3 Stage)	WK0121CK WK0126CK	Cast Iron Stainless Steel
	Discharge Flange K620 (1 and 2 Stage)	WK0121CK WK0126CK	Cast Iron Stainless Steel
	Discharge Flange K800 (1 and 2 Stage)	WK0122CK WK0127CK	Cast Iron Stainless Steel
	Connecting Rod K115, K175, K345 and K620	PK0251CK PK0256CK	Cast Iron Stainless Steel
	Connecting Rod K800	PK0252CK PK0257CK	Cast Iron Stainless Steel

Continental Pump Company

29425 State Hwy B | Warrenton, Missouri 63383 | Tel: 636-456-6006 | Fax: 636-456-4337 | Email: sales@con-pump.com

www.continentalultrapumps.com

Please Contact Us for Pricing.





Part	Part Name	Continental Pump Part Number	Materials
	Gear Joint Shell	PK0911CK PK0916CK	Cast Iron Stainless Steel
	Rotor 6K115	C76KJ1CK C86KJ1CK	Cast Iron Stainless Steel
	Rotor 1K175	C71KK1CK C81KK1CK	Carbon Steel Stainless Steel
	Rotor 2K175	C72KK1CK C82KK1CK	Carbon Steel Stainless Steel
	Rotor 4K175	C74KK1CK C84KK1CK	Carbon Steel Stainless Steel
	Rotor 6K175	C76KK1CK C86KK1CK	Cast Iron Stainless Steel
	Rotor 1K345	C71341CK C81341CK	Carbon Steel Stainless Steel
	Rotor 2K345	C72341CK C82341CK	Carbon Steel Stainless Steel

Continental Pump Company

29425 State Hwy B | Warrenton, Missouri 63383 | Tel: 636-456-6006 | Fax: 636-456-4337 | Email: sales@con-pump.com

www.continentalultrapumps.com

Please Contact Us for Pricing.

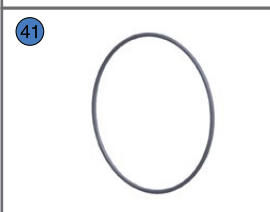
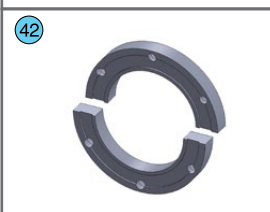
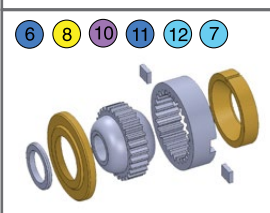
Part	Part Name	Continental Pump Part Number	Materials
	Rotor 3K345	C73341CK C83341CK	Carbon Steel Stainless Steel
	Rotor 1K620	C71621CK C81621CK	Carbon Steel Stainless Steel
	Rotor 2K620	C72621CK C82621CK	Carbon Steel Stainless Steel
	Rotor 1K800	C71801CK C81801CK	Carbon Steel Stainless Steel
	Rotor 2K800	C72801CK C82801CK	Carbon Steel Stainless Steel
	O-Ring for Gear Joint Shell	PK113QCK PK113BCK PK113FCK	Buna EPDM Viton
	Head Ring (2 Piece) K115, K175, K345, K620 and K800	PK033DCK PK033SCK	Carbon Steel Stainless Steel
	Gear Joint Kit Includes: (RK0761) Rotor Keys (Set of 2), (AK0952) 1 Ring Gear, (AK0951) 1 Gear Ball, (PK0981) 1 Thrust Plate Primary, (PK0982) 1 Thrust Plate Secondary, (KJ0891) 1 Seal Supports	KPK951CK	Carbon Steel

Continental Pump Company

Please Contact Us for Pricing.

Part	Part Name	Continental Pump Part Number	Materials
<p>5 13 41</p>	Gear Joint Seal Kit Includes: (PK087*) 2 Gear Joint Seals, (TK111*) 1 Drive Shaft Head O-Ring and (PK113*) 1 Rotor Head O-Ring <i>* Select material code Q, B or F</i>	KPK87QCK KPK87BCK KPK87FCK	Buna (Q) EPDM (B) Viton (F)
<p>5 12 13 41</p>	Gear Joint Seal Kit (NEW STYLE) Includes: (PK087*) 2 Gear Joint Seals, (PK0891) 2 Seal Supports, (TK111*) 1 Drive Shaft Head O-Ring and (PK113*) 1 Rotor Head O-Ring <i>* Select material code Q or F</i>	KPK88QCK KPK88FCK	Buna (Q) Viton (F)
<p>1 15 19</p>	Bearing Kit (G1) Includes: (PK0311) 2 Roller Bearings, (PK0611) 1 Radial Grease Seal and (AK0611) 1 Thrust Grease Seal	KPK291CK	Carbon Steel

Continental Pump Company

29425 State Hwy B | Warrenton, Missouri 63383 | Tel: 636-456-6006 | Fax: 636-456-4337 | Email: sales@con-pump.com

www.continentalultrapumps.com



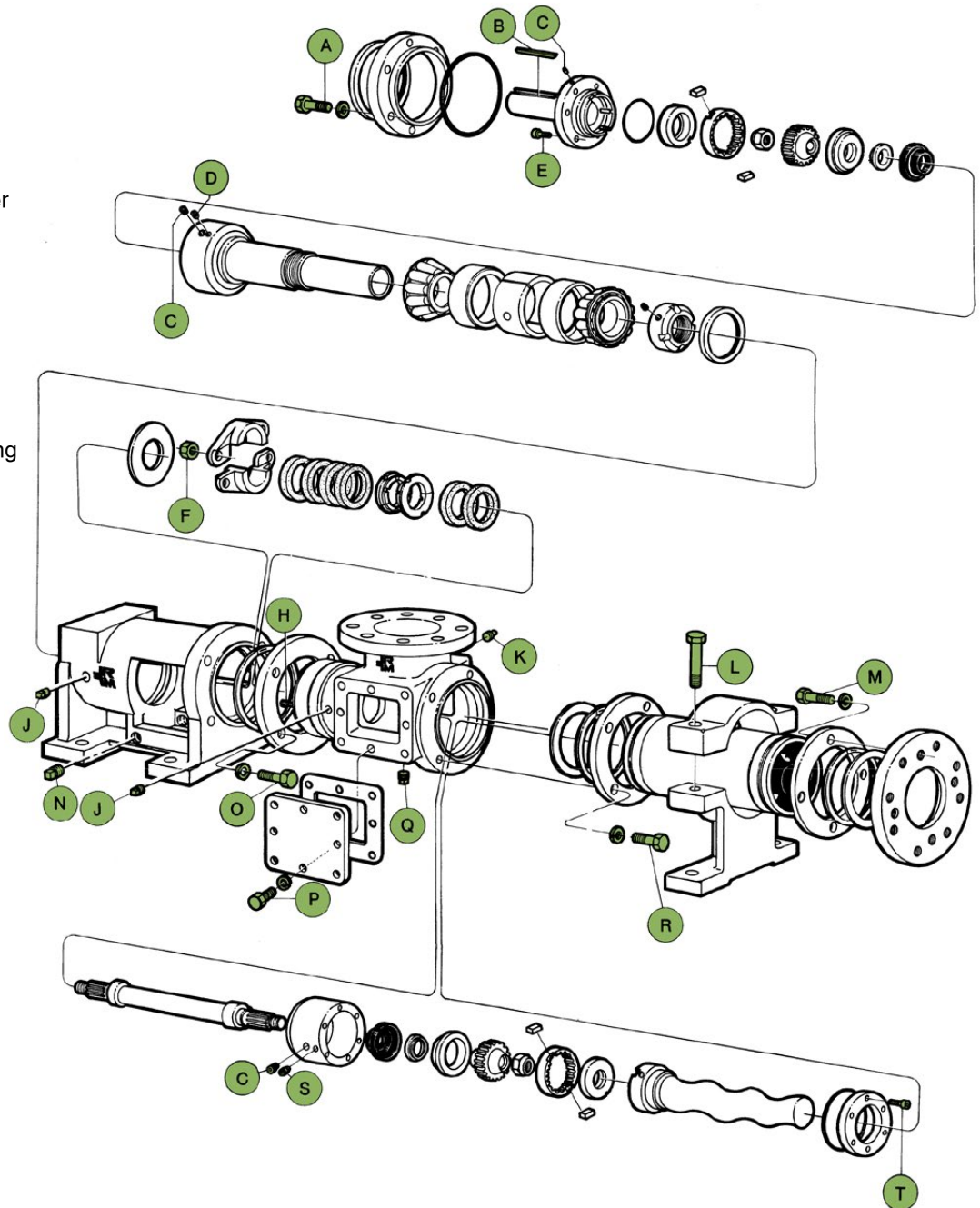

- Ⓐ Hex Head Screw w/ Lock Washer
- Ⓑ Shaft Key
- Ⓒ Pipe Plug (Stainless Steel)
- Ⓓ Set Screw (with thread seating compound)
- Ⓔ Socket Head Screw
- Ⓕ Hex Nut, Packing
- Ⓖ Hex Head Screw Lock Washer
- Ⓗ Stud, Packing
- Ⓙ Pipe Plug
- Ⓚ Zerk Fitting
- Ⓛ Hex Head Bolt
- Ⓜ Hex Head Screw w/ Lock Washer
- Ⓝ Pipe Plug
- Ⓞ Hex Head Screw Lock Washer
- Ⓟ Set Screw (Stainless Steel with Thread Sealing Compound)
- Ⓠ Socket Head Screw
- Ⓡ Set Screw
- Ⓢ Set Screw for Gear Joint Shell
- Ⓣ Socket Head Screw for Head Ring



Continental Pump Company

29425 State Hwy B | Warrenton, Missouri 63383 | Tel: 636-456-6006 | Fax: 636-456-4337 | Email: sales@con-pump.com

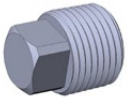
Please Contact Us for Pricing.

Part	Part Name	Continental Pump Part Number	Materials
	1/8" NPT Pipe Plug for Drive Shaft Head, Drive Shaft and Gear Joint Shell (3 Required)	C	Stainless Steel
	5/16" – 18 x 3/4" Set Screw for Gear Joint Shell	D	Steel
	3/8" – 16 x 2 1/2" NPT Pipe Plug for Drive Shaft Head, Drive Shaft and Gear Joint Shell (2 Required)	H	Steel
	3/4" NPT Pipe Plug for Bearing Housing (3 Required)	N	Steel
	5/16" – 18 x 5/8" Set Screw for Gear Joint Shell	S	Stainless Steel
	10 – 24 x 1/2" Socket Head Screw for Head Ring (Set of 6)	T	Steel

Continental Pump Company

29425 State Hwy B | Warrenton, Missouri 63383 | Tel: 636-456-6006 | Fax: 636-456-4337 | Email: sales@con-pump.com

www.continentalultrapumps.com



CK Series K Frame

RETURN TO EXPLODED VIEW PARTS LIST

Please Contact Us for Pricing.

Ref. No.	Description	Drive End											
		E	Qty	F	Qty	G	Qty	H	Qty	J	Qty	K	Qty
(A)	Hex Head Screw Lock Washer	3/8-16 x 1-3/4 3/8	6 6	1/2-13 x 1-3/4 1/2	6 6	1/2-13 x 2 1/2	6 6	5/8-11 x 2 5/8	6 6	5/8-11 x 2-1/4 5/8	6 6	3/4-10 x 2-3/4 3/4	8 8
(B)	Shaft Key	1/2 x 1/2 x 3-3/4	1	1/2 x 1/2 x 3-3/4	1	5/8 x 5/8 x 3-1/2	1	3/4 x 3/4 x 3-1/4	1	7/8 x 7/8 x 4-1/4	1	1 x 1 x 4	1
(C)	Pipe Plug (stainless steel)	1/8 NPT	3	1/8 NPT	3	1/8 NPT	3	1/8 NPT	3	1/8 NPT	3	1/8 NPT	3
(D)	Set Screw (with thread sealing compound)	Not Required		5/16-18 x 3/4	1	3/8-16 x 1	1	3/8-16 x 1	1	3/8-16 x 1	1	3/8-16 x 1	1
(E)	Socket Head Screw	3/8-16 x 3/4	6	1/2-13 x 1	6	1/2-13 x 1-1/4	6	5/8-11 x 1-1/4	6	3/4-10 x 1-1/2	6	3/4-10 x 1-1/2	6
(F)	Hex Nut, Packing	3/8-16	2	3/8-16	2	1/2-13	2	5/8-11	2	5/8-11	2	3/4-10	2
(G)	Hex Head Screw Lock Washer	Not Required		Not Required		Not Required		Not Required		J335 3/4-10 x 2-3/4 3/4	8 8	Not Required	
(H)	Stud, Packing	3/8-16 x 2-1/2	2	3/8-16 x 2-1/2	2	1/2-13 x 3-1/2	2	5/8-11 x 4	2	5/8-11 x 4	2	3/4-10 x 4-1/2	2
(J)	Pipe Plug	1/8 NPT	1	1/8 NPT	1	1/8 NPT	1	1/8 NPT	1	1/8 NPT	1	1/8 NPT	1
(K)	Zerk Fitting	1/8 NPT	1	1/8 NPT	1	1/8 NPT	1	1/8 NPT	1	1/8 NPT	1	1/8 NPT	1
(L)	Hex Head Bolt	E008G1, E012G1, E022G1 5/8-11 x 3-1/4 E036G1, E050G1 3/4-10 x 3-1/2	4 2	F012G1, F022G1 5/8-11 x 3-1/4 F036G1, F050G1 3/4-10 x 3-1/2 F065G1, F090G1 3/4-10 x 4-1/2	6 4	G022G1, G036G1, G050G1 5/8-11 x 3-1/4 3/4-10 x 3-1/2 G065G1, G090G1, G115G1 3/4-10 x 4-1/2	4 6	H065G1, H090G1, H115G1, H175G1 3/4-10 x 4-1/2 H065G1, H090G1 3/4-10 x 3-1/2	6 6	J065G1, J090G1, J115G1, J175G1, J335G1 3/4-10 x 4-1/2	6	K115G1, K175G1, K335G1, K345G1 5/8-11 x 4	2
(M)	Hex Head Screw Lock Washer	1 & 2E008G1, 1 & 2E012G1, 1, 2 & 4E022G1 5/8-11 x 1-1/2 5/8	4 4	1 & 2F022G1 5/8-11 x 1-1/2 5/8	4 4	1 & 2G036G1, 1 & 2G050G1 3/4-10 x 1-3/4 3/4	4 4	1 & 2H065G1, 1 & 2H090G1, 2 & 4H115G1 3/4-10 x 2 3/4	6 6	1 & 2J115G1 3/4-10 x 2 3/4	6 6	1 & 2K175G1, 1K335G1, 1K345G1 3/4-10 x 2 3/4	8 8
	Hex Head Screw Lock Washer	1 & 2E050G1, 4E012G1 3/4-10 x 1-3/4 3/4	8 8	1 & 2F090G1, 4 & 6F022G1 3/4-10 x 2 3/4	12 12	1 & 2G115G1, 6G022G1, 6G036G1, 6G050G1 3/4-10 x 2 3/4	12 12	6H036G1, 6H050G1, 4 & 6H065G1, 4 & 6H090G1 3/4-10 x 2 3/4	12 12	6J065G1, 6J090G1, 4 & 6J115G1 3/4-10 x 2 3/4	12 12	6K115G1, 4K175G1, 2 & 3K335G1, 2 & 3K345G1 3/4-10 x 2-1/2 3/4	12 12
	Hex Head Screw Lock Washer	1 & 2E036G1 3/4-10 x 1-3/4 3/4	4 4	1, 2 & 4F036G1, 1, 2 & 4F050G1 3/4-10 x 1-3/4 3/4	4 4	4G036G1, 4G050G1, 1 & 2G090G1 3/4-10 x 2 3/4	6 6	1 & 2H175G1 3/4-10 x 2 3/4	8 8	1 & 2J335G1 3/4-10 x 2 3/4	8 8	1 & 2K800 7/8-9 x 2-1/2 7/8	12 12
	Hex Head Screw Lock Washer			6F012G1 3/4-10 x 2 3/4	8 8								
	Hex Head Screw Lock Washer			1 & 2F065G1 3/4-10 x 2 3/4	6 6								
(N)	Pipe Plug	3/4 NPT	2	3/4 NPT	2	3/4 NPT	2	3/4 NPT	2	3/4 NPT	2	3/4 NPT	2
(O)	Hex Head Screw Lock Washer	5/8-11 x 1-3/4 5/8	4 4	3/4-10 x 2 3/4	4 4	3/4-10 x 2 3/4	6 6	3/4-10 x 2 3/4	6 6	3/4-10 x 2-1/4 3/4	6 6	3/4-10 x 2-1/2 3/4	8 8
(P)	Hex Head Screw Lock Washer	5/16-18 x 1 5/16	16 16	3/16 x 1 3/8	16 16	3/8-16 x 1 3/8	16 16	3/8-16 x 1 3/8	16 16	1/2-13 x 1-1/4 1/2	16 16	1/2-13 x 1-1/4 1/2	16 16
(Q)	Pipe Plug	3/4 NPT	1	3/4 NPT	1	3/4 NPT	1	3/4 NPT	1	3/4 NPT	1	3/4 NPT	2
												K800 1-1/2 NPT	3
(R)	Hex Head Screw Lock Washer	E008G1, E012G1, E022G1 5/8-11 x 1-1/2 5/8	4 4	F012G1 5/8-11 x 2 5/8	4 4	G022G1 3/4-10 x 2-1/2 3/4	4 4	H036G1, H050G1 3/4-10 x 2-1/2 3/4	6 6	J065G1, J090G1, J115G1 3/4-10 x 2 3/4	6 6	K175G1, K335G1, K345G1 3/4-10 x 2-1/2 3/4	8 8
	Hex Head Screw Lock Washer	E036G1 3/4-10 x 2 3/4	4 4	F022G1 5/8-11 x 1-1/2 5/8	4 4	G036G1, G050G1 3/4-10 x 2 3/4	4 4	H065G1, H090G1, H115G1 3/4-10 x 2 3/4	6 6	J175G1, J335G1, J345G1 3/4-10 x 2 3/4	8 8	K115G1 3/4-10 x 2-3/4 3/4	8 8
	Hex Head Screw Lock Washer			F036G1, F050G1 3/4-10 x 2-1/4 3/4	4 4	G065G1, G090G1 3/4-10 x 2 3/4	6 6	H175G1 3/4-10 x 2 3/4	8 8			1 & 2K800 7/8-9 x 3 7/8	12 12
	Hex Head Screw Lock Washer			F065G1 3/4-10 x 2-1/4 3/4	6 6								
(S)	Set Screw (stainless steel with thread sealing compound)	5/16-18 x 5/8	1	5/16-18 x 5/8	1	5/16-18 x 5/8	1	5/16-18 x 5/8	1	3/8-16 x 3/4	1	3/8-16 x 3/4	1
(T)	Socket Head Screw	10-24 x 1/2	6	1/4-20 x 5/8	6	1/4-20 x 3/4	6	5/16-18 x 3/4	6	3/8-16 x 1	6	1/2-13 x 1-1/4	6

Continental Pump Company

29425 State Hwy B | Warrenton, Missouri 63383 | Tel: 636-456-6006 | Fax: 636-456-4337 | Email: sales@con-pump.com

www.continentalultrapumps.com