

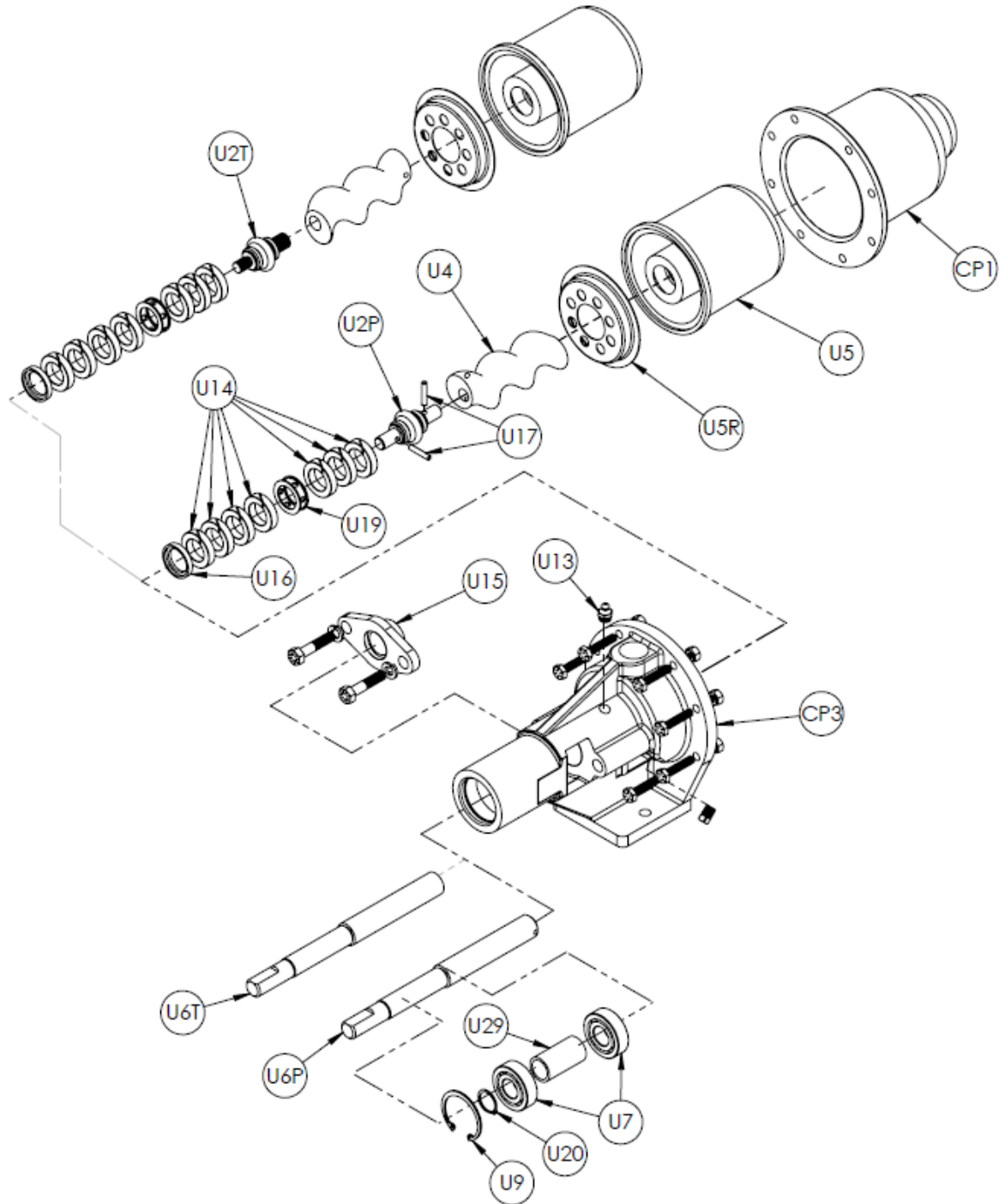

Continental Progressive Cavity Pump CP Model CP44 Packed Seal Pump



Continental Pump Company

29425 State Hwy B | Warrenton, Missouri 63383 | Tel: 636-456-6006 | Fax: 636-456-4337 | Email: sales@con-pump.com
Visit us at: www.continentalultrapumps.com



CP Model Number Nomenclature:

Materials used in the pumps are based on the fluid to be handled and are indicated in the model number nomenclature.

CP44-CSQDTV

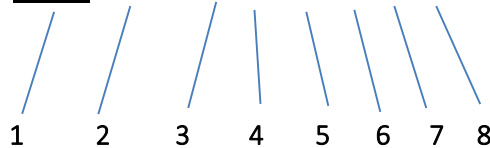

- (1): Indicates the pump model designation (CP, CPM, CPML Model)
- (2): Indicates the pump frame size designation
- (3): Indicates the pump body casting material
- (4): Indicates the rotor material
- (5): Indicates the stator material
- (6): Indicates seal type: Mechanical Seal or Packed Seal (For Mechanical use M, for Packed use D)
- (7): Indicates if the Drive Shaft, Flex Joint, and Rotor is Pinned or Threaded. (For pinned use P, for threaded use T)
- (8): Indicates if the pump has vertical suction housing. If horizontal is preferred no designation will be used.

Material of Construction

Continental Part Description	Continental Letter Designation	Part Materials
Pump Body	C	Cast Iron
	S	316 Stainless Steel (CF8M)
Rotor	D	Chrome Plated Alloy Steel
	S	Chrome Plated Stainless Steel
Stator	Q	Buna Nitrile
	B	EPDM
	F	Viton®
Seal Type	M	Mechanical Seal
	D	Packing Gland

Mechanical Seal and Packed Seal options are available for all frame sizes (15, 22, 33, 44, 56, and 67).

The Pinned Drive Shaft, Flex Joint, and Rotor option is also available for all frame sizes. The Threaded option is available only in frame sizes 15, 22, 33, 44, and 56; Size 67 has pinned option only.







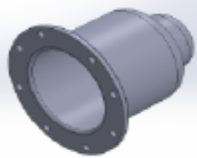

Continental Pump Company

29425 State Hwy B | Warrenton, Missouri 63383 | Tel: 636-456-6006 | Fax: 636-456-4337 | Email: sales@con-pump.com
 Visit us at: www.continentalultrapumps.com

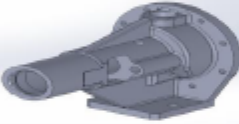

CP Pump

Replacement Parts
for CP44 Packed Seal Pump

Part	Part Name	Continental Pump Part Number	For Continental Pump Model
	Suction Body	CP1-15C CP1-15S	CP44
	Suction Body, Vertical	CPV1-15C CPV1-15S	CP44
	Discharge Housing for Packed Seal with 1/8" NPT Drain Plug (Plug Sold Separately)	CP3-15DC CP3-15DS	CP44
	Flexible Joint, Pinned	U2-15PQS U2-15PBS U2-15PFS	CP44
	Flexible Joint, Threaded	U2-15TQS U2-15TBS U2-15TFS	CP44
	Rotor, Pinned & Threaded	U4-44PTS	CP44
	Stator	U5-44Q U5-44B U5-44F	CP44
	Stator Barrier (Optional)	U5R-15S	CP44

Continental Pump Company

29425 State Hwy B | Warrenton, Missouri 63383 | Tel: 636-456-6006 | Fax: 636-456-4337 | Email: sales@con-pump.com
Visit us at: www.continentalultrapumps.com



Part	Part Name	Continental Pump Part Number	For Continental Pump Model
	Shaft, Pinned	U6-15PDS	CP44
	Shaft, Threaded	U6-15TDS	CP44
	Ball Bearing (2 Required)	U7-15	CP44
	Retaining Ring	U9-15	CP44
	1/8" NPT Drain Plug for Discharge Housing (Sold individually or in Bolt Kit)	U12-15C U12-15S	CP44
	1/8" NPT Non Vented Grease Fitting	U13-15C	CP44
	Packing Set, Teflon Coated	U14-15FC	CP44
	Packing Gland	U15-15DC U15-15DS	CP44
	Packing Gland Insert	U16-15S	CP44
	Roll Pins (for Pinned Pump Only, 2 Required)	U17-15S	CP44
	Lantern Ring	U19-15S	CP44
	Shaft Retaining Ring	U20-15	CP44
	Bearing Spacer	U29-15	CP44



Continental Pump Company

29425 State Hwy B | Warrenton, Missouri 63383 | Tel: 636-456-6006 | Fax: 636-456-4337 | Email: sales@con-pump.com
Visit us at: www.continentalultrapumps.com



CP Pump

Replacement Kits
for CP44 Packed Seal Pump

Part	Part Name	Continental Pump Part Number	For Continental Pump Model
	<u>Pinned Rebuild Kit:</u> Includes: QTY 1: Flex Joint, Rotor, Stator, Packing Set; Qty 2: Roll Pins	CPD44K-PQS CPD44K-PBS CPD44K-PFS	CP44
	<u>Threaded Rebuild Kit:</u> Includes: QTY 1: Flex Joint, Rotor, Stator, Packing Set.	CPD44K-TQS CPD44K-TBS CPD44K-TFS	CP44
	<u>Bolt Kit:</u> Includes Qty 8: Housing Bolts, Washers & Nuts. Qty 2: Packing Gland Bolts & Washers. Qty 1: 1/8" NPT Drain Plug & 1/8" NPT Non-Vented Grease Fitting	U10-15DC	CP44

Continental Pump Company

29425 State Hwy B | Warrenton, Missouri 63383 | Tel: 636-456-6006 | Fax: 636-456-4337 | Email: sales@con-pump.com
 Visit us at: www.continentalultrapumps.com



Materials of Construction

All Continental Pump casting materials are Class 40# grey cast iron and CF8M (316) stainless steel. The best metal for your application would depend on how corrosive your liquid is. We offer an epoxy coating for an additional charge and can be applied to the suction housing and discharge. The epoxy seals the cast iron from the material being pumped.

Stators are available in 3 types of elastomers. The rubber materials are: Buna Nitrile, EPDM and Viton®. The rubber that is best for your application depends on what liquid you are pumping and at what temperature, as it plays a vital role in which to select.

The rotors are available in Chrome Plated Stainless Steel.

Abrasive Resistance Mechanical Seals are a great upgrade for your more abrasive applications. By adding a Stator Barrier, which is recommended in any negative suction and/or vacuum application to help protect the stator. There are lots of variables to take in consideration to know if this is right for your application. Contact us with your application information to see if this is for you.

Looking for simplicity? We offer complete Progressive Cavity Pump Units. They are constructed on a steel base to fit your specific application needs. The Unit consists of a Pump, a Steel Base & Guard, a Gear Reducer and Motor. Also available are Belt Drive Units, Gas or Diesel Engines, and many other base options.

Space Challenged? If you are needing a different arrangement from traditional piping, we have vertical suction housings available in the CP Model.

Don't need a complete pumping unit but looking for drive options? We can still help, whether attached to a pump or sold separately we can supply you with VFD's, Motors and Bases.

Continental Pump Company

29425 State Hwy B | Warrenton, Missouri 63383 | Tel: 636-456-6006 | Fax: 636-456-4337 | Email: sales@con-pump.com
Visit us at: www.continentalultrapumps.com